

FRP FUME EXHAUSTERS

- Capacities to 84,000 CFM
- Two wheel choices
- Static pressures to 25"WG
- Temperatures to 250°F.



Fiberglass-reinforced-plastic fans for handling corrosive gas streams in a wide variety of process applications...



THE NEW YORK BLOWER COMPANY
7660 Quincy Street
Willowbrook, IL 60527-5530

Visit us on the Web: <http://www.nyb.com>
Phone: (800) 208-7918 Email: nyb@nyb.com

FRP FUME EXHAUSTERS



Size 182
Arrangement 1
FRP Fume Exhauster,
counterclockwise, Bottom Angular Up,
with optional unitary base, inspection
port, outlet damper, inlet box.

BACKWARDLY INCLINED WHEELS

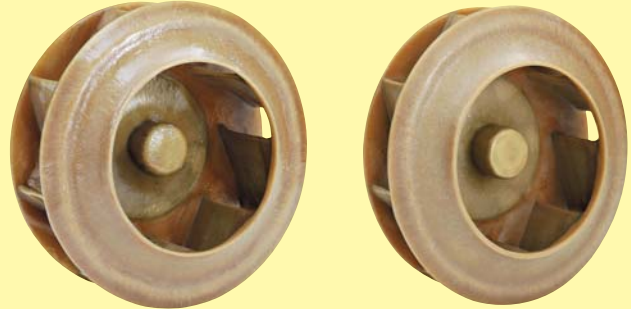

MEDIUM PRESSURE [MP] HIGH PRESSURE [HP]

FRP Fume Exhauster backwardly inclined wheels provide high efficiency and quiet operation with a non-overloading horsepower characteristic. Made of premium-quality, corrosion-resistant vinyl ester resin. Metal hub, shaft, and stainless-steel fasteners are encapsulated in full-thickness FRP.

DESIGN FEATURES

The New York Blower Company's FRP Fume Exhauster [FE] is designed so that all parts exposed to the airstream are constructed of high-quality corrosion-resistant fiberglass reinforced plastic. The FE is resistant to attack from most chemicals and is ideally suited to applications in the chemical, pulp and paper, wastewater-treatment, fertilizer, pharmaceutical, and metals industries.

- Eight sizes: 18", 24", 30", 36", 42", 48", 54" and 60" wheel diameters.
- Capacities to 84,000 CFM.
- Static pressures to 25"WG.
- Temperatures to 250°F.
- Choice of arrangements: Sizes 182 through 362 [medium-pressure fans only] available in Arrangement 10. Sizes 182 through 602 available in Arrangements 1, 8, 9, and 9-E. Sizes 362 through 602 also available in Arrangement 9-F.

CONSTRUCTION FEATURES

- Housing is made of premium-quality, corrosion-resistant polyester resin. By using male molds, housing interior surfaces are smooth, improving efficiency and reducing the potential for material build-up.
- Flanged outlet for easy in-duct connection.
- Slip inlet suitable for flexible-sleeve inlet connection.
- All Arrangement 10 fans, and all other arrangements up to Size 302, are rotatable to any of five discharge positions.
- Lifting eyes on all fans for ease of handling.
- Welded steel base is constructed of heavy-gauge components for structural strength and durability. Arrangement 10 base features self-contained motor platform.
- Neoprene gasketing at all bolted FRP joints.
- Fan exterior is coated with gray epoxy enamel.
- Close-fitting, Teflon® shaft-hole closure limits the free exchange of gases through the shaft-hole opening. [Teflon is a registered trademark of DuPont.]
- FE wheels are dynamically balanced before final assembly. After assembly, all fans are given a final trim balance check at the specified running speed.
- Meets ASTM D 4167 when fan is purchased with surface veil.



AMCA SEAL

The New York Blower Company certifies that the FRP Fume Exhausters shown herein are licensed to bear the AMCA Seal. The ratings shown are based on tests and procedures performed in accordance with AMCA Publication 211 and comply with the requirements of the AMCA Certified Ratings Program.

ACCESSORIES/MODIFICATIONS

- **Parallel-blade outlet damper**—for flow control. All airstream parts are constructed of FRP.
- **Flanged outlet drilling**—for ease of direct connection; dimensions shown on page 12.
- **Unitary base**—available with spring or rubber-in-shear [R-I-S] isolators. Isolation rails are available for Arrangement 10 fans without inlet boxes.
- **Flanged inlet**—plain or drilled [see page 12 for drilling pattern].
- **Drain**—threaded FRP drain with PVC plug, 1" npt, at lowest point of housing scroll.
- **Inspection port**—allows examination of fan interior. Located on drive-side half of housing at 2 or 10 o'clock, opposite discharge. Opening is 6" diameter on Sizes 182 and 242, 8" on Sizes 302 through 422, and 12" on Sizes 482 through 602.
- **Positive screw adjustment**—two threaded rods provide easy motor platform/V-belt adjustment. [Arrangement 10 fans only].
- **Arrangement 10 weather cover/belt guard**—provides motor and drive protection, and can be easily removed for inspection and maintenance. Louvered side panels provide ample motor ventilation.
- **Safety equipment**—belt guards and shaft and bearing guards are available for Arrangements 1, 9, 9-E, and 9-F fans, and coupling guards for Arrangement 8 fans.
- **Inlet box** [includes support leg]—for Sizes 182 through 542. Minimizes losses at inlet. See pages 4 and 13 for details.
- **Cleanout door**—provides access for cleaning and inspecting fan interior.
- **Shaft seal**—Viton® elements in FRP casing. Type 316 SST sleeve covers shaft for use with seal. Teflon seal and Hastelloy C-276 sleeve available. [Viton is a registered trademark of DuPont Dow Elastomers.]
- **Surface veil**—for added protection against certain corrosives. Provides compliance to ASTM D 4167.
- **All-vinyl ester airstream**—provides additional protection from certain corrosives.
- **Graphite impregnation**—to control static electricity. The gas-stream surfaces are grounded to the fan base.
- **Narrow-width construction**—to optimize the point of operation. Available on all sizes to 75% of full width on medium pressure fans and 67% on high pressure fans. Maximum safe wheel speed increases as width decreases.



Size 182 Arrangement 1
FRP Fume Exhauster,
counterclockwise Bottom Angular Up,
with optional unitary base,
inspection port, inlet box,
outlet damper, motor,
drive, and guards.

Size 302
Arrangement 9
FRP Fume Exhauster,
clockwise
Top Horizontal, with
optional cleanout
door, inlet flange,
flange drilling,
graphite
impregnation,
and guards.



SAFETY EQUIPMENT

Safety accessories are available from **nyb**, but selection of the appropriate devices is the responsibility of the system-designer who is familiar with the particular installation, or application, and can provide for guards for all exposed moving parts as well as protection from access to high-velocity airstreams. Neither **nyb** nor its sales representatives is in a position to make such a determination. Users and/or installers should read "Recommended Safety Practices for Air Moving Devices" as published by the Air Movement and Control Association International, Arlington Heights, Illinois.

INLET BOXES

FOR FRP FUME EXHAUSTERS

Optimum fan performance requires straight airflow into the fan inlet. Due to space constraints, this is not always possible. Elbows are used to change airflow direction. However, when airflow is turned 90° at the fan inlet, there is a loss of fan performance due to eccentric loading of the fan wheel. **nyb's** aerodynamically designed inlet box minimizes the entry loss and allows accurate prediction of the loss so it can be included in overall system calculation. See page 13 for dimensions.

STANDARD FEATURES

FRP inlet boxes are offered for Sizes 182 through 542 FRP Fume Exhausters. The inlet box is designed to attach to the inlet flange of the fan. A support leg with mounting plate is standard on all inlet boxes. When furnished complete with a unitary base or isolation base, the base must be extended to meet the support leg. The inlet box/support leg assembly is not intended to support additional weight from ductwork or any other system components.

The use of male molds and smooth resin-rich surfaces ensures efficient performance and excellent corrosion resistance.

The resin system is the same high-quality, corrosion-resistant system used in **nyb** FRP Fume Exhauster housings.

FRP inlet boxes are made in two sections, gasketed and bolted together with 316 stainless-steel hardware. Boxes can be fitted with drains.

An epoxy-based coating is applied to the exterior surface to be consistent with the finish on the exterior surface of the fan.

FRP inlet boxes are normally shipped separately for ease of handling.



INLET BOX POSITIONS

Position of inlet box is determined from drive side of fan.

Inlet-box positions 135°, 180°, and 225° often require special construction to avoid interference with the fan support structure.

When other accessories such as unitary base are required, a special layout is necessary.

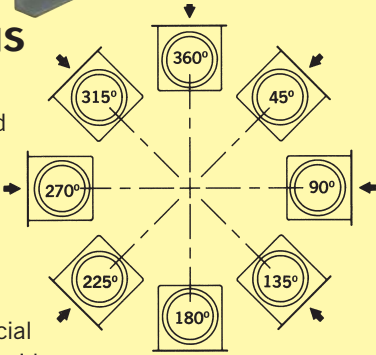

CORRECTION FACTORS FOR DETERMINING PERFORMANCE OF FRP FUME EXHAUSTERS WITH INLET BOXES

Fans equipped with inlet boxes require selection at a pressure that compensates for losses occurring as a result of the inlet-box configuration. The required steps for selection and an example are shown on the bottom of page 5.

CHART I

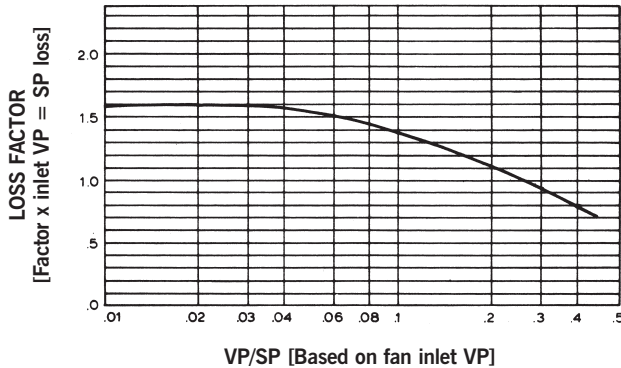

How to Use Performance Tables

For a given fan size, CFM, and static pressure, performance tables can be used to obtain outlet velocity, wheel RPM, and BHP. If capacities are at conditions other than 70°F, sea level, or standard density [.075 lbs./cu.ft.], correction factors must be applied to static pressure and BHP.

STEPS TO FOLLOW	STEPS	EXAMPLE:
		Size 242 Medium Pressure Fan, Arrangement 1, to handle 9000 CFM at 8" WG at 200°F. at sea level.
Determine fan static pressure at standard conditions. If temperature or altitude is involved, correct for air density [see Charts II and III].	1	Chart II shows 1.25 correction factor for 200°F. 8" WG x 1.25 = 10" WG at 70°F.
Select size, RPM, and BHP of fan from capacity tables.	2	Capacity table shows 2204 RPM, 19.6 BHP for Size 242 MP fan at 9000 CFM at 10" WG at 70°F.
Check the maximum safe speed of the fan shown below in Chart IV.	3	Maximum safe speed of Size 242 medium-pressure fan, Arrangement 1, is 2700 RPM at 70°F.
Apply temperature maximum safe speed factors from Chart V to maximum safe speed of fan from Step 3 to determine new maximum safe speed when temperature is involved.	4	Chart V shows .94 correction factor for 200°F. .94 x 2700 RPM = 2538 RPM at 200°F.
Determine actual performance by dividing static pressure and BHP* from Step 2 by the correction factor in Step 1.	5	Actual performance: 9000 CFM at 8" WG at 2204 RPM at 15.8 BHP at 200°F.

*NOTE: Motor should be selected for BHP @ 70°F. to insure proper operation during "cold starts."

CHART II CORRECTION FACTORS FOR TEMPERATURE [°F.]	
Temperature	Factor
-50	.77
-25	.82
0	.87
20	.91
40	.94
70	1.00
100	1.06
130	1.11
160	1.17
200	1.25
250	1.34

CHART III CORRECTION FACTORS FOR ALTITUDE [feet above sea level]	
Altitude	Factor
0	1.00
1000	1.04
2000	1.08
3000	1.12
4000	1.16
5000	1.20
6000	1.25
7000	1.30
8000	1.35
9000	1.40
10000	1.45

CHART IV MAXIMUM SAFE WHEEL SPEED AT 70°F. [RPM]		
Size	All arrangements	
	MP	HP
182	3710	4000
242	2700	3300
302	2155	2650
362	1725	2100
422	1475	1840
482	1250	1500
542	1045	1300
602	945	1170

CHART V TEMPERATURE [°F.] SAFE SPEED FACTORS	
Temperature	Factor
70-150	1.00
200	.94
225	.86
250	.73

Note: 250°F. is maximum allowable temperature.

NOTE: If correction for both temperature and altitude is required, multiply factors from Chart II and III together: 3000 ft. and 200°F. 1.12 x 1.25 = 1.40 [combined factor].

HOW TO CALCULATE PRESSURE LOSS WHEN USING AN INLET BOX

STEPS TO FOLLOW	STEPS	EXAMPLE:
		Required: Size 242 Medium Pressure Fan for 9000 CFM at 10" SP at 70°F.
Determine air velocity at fan inlet: CFM ÷ fan inlet area = air velocity (V)	1	9000 CFM ÷ 3.14 [fan inlet area, see page 13] = 2866 FPM.
Determine velocity pressure at fan inlet. VP = (V ÷ 4005) ² x (density ÷ .075)	2	(2866 ÷ 4005) ² = .51" VP
Determine VP/SP ratio at conditions.	3	.51 VP ÷ 10" SP = .05 VP/SP
Determine VP loss factor from Chart I [see page 4].	4	VP factor at .05 VP/SP = 1.55 [from Chart I]
Determine inlet-box loss by multiplying the VP factor from Step 4 times the velocity pressure from Step 2.	5	1.55 x .51" VP = .79" loss
Add the loss from Step 5 to the required system SP and select fan accordingly.	6	.79 + 10" = 10.79" SP. Select fan, motor, and drive for 9000 CFM at 10.79" SP at 70°F.

NOTE: The above procedure does not consider the slight change in efficiency. Actual operation will require slightly lower horsepower than that indicated.

PERFORMANCE FOR FRP FUME EXHAUSTERS WITH **MP** WHEELS

SIZE 182		MP		Wheel diameter: 18 1/4"				Inlet diameter: 18" I.D.				Maximum BHP = .409 $\left[\frac{\text{RPM}}{1000} \right]^3$									
		Wheel circumference: 4.78'				Fan outlet area = 1.92 sq. ft.															
CFM	OV	2"SP		4"SP		6"SP		8"SP		10"SP		12"SP		14"SP		16"SP		18"SP		19"SP	
		RPM	BHP	RPM	BHP	RPM	BHP	RPM	BHP	RPM	BHP	RPM	BHP	RPM	BHP	RPM	BHP	RPM	BHP	RPM	BHP
3200	1667	1683	1.80	1978	3.00	2239	4.35	2475	5.75	2704	7.34	2929	9.06	3170	11.1						
3400	1771	1745	2.00	2036	3.26	2285	4.65	2525	6.15	2736	7.70	2948	9.43	3172	11.4	3383	13.5				
3600	1875	1806	2.20	2093	3.53	2336	4.97	2566	6.52	2776	8.12	2968	9.77	3178	11.7	3385	13.8				
3800	1979	1861	2.39	2152	3.83	2390	5.30	2607	6.88	2815	8.53	3006	10.3	3196	12.1	3391	14.2	3586	16.4	3685	17.6
4000	2083	1922	2.61	2214	4.15	2448	5.68	2659	7.33	2860	9.01	3052	10.8	3234	12.7	3409	14.7	3604	17.0	3697	18.2
4200	2188	1991	2.88	2275	4.47	2504	6.07	2710	7.76	2905	9.50	3097	11.4	3272	13.3	3438	15.2	3612	17.4	3700	18.5
4400	2292	2065	3.19	2338	4.83	2564	6.50	2760	8.17	2948	9.98	3141	11.9	3309	13.8	3477	15.9	3643	18.1		
4600	2396	2139	3.51	2404	5.23	2623	6.94	2821	8.70	3005	10.6	3184	12.5	3354	14.5	3525	16.6	3675	18.7		
4800	2500	2214	3.87	2466	5.63	2681	7.38	2880	9.24	3053	11.1	3227	13.1	3398	15.1	3563	17.3				
5000	2604	2289	4.25	2526	6.04	2742	7.86	2938	9.79	3113	11.7	3276	13.7	3442	15.8	3608	18.1				
5200	2708	2365	4.65	2585	6.45	2803	8.35	2995	10.3	3166	12.3	3331	14.4	3492	16.6	3653	18.8				

SIZE 242		MP		Wheel diameter: 24 1/2"				Inlet diameter: 24" I.D.				Maximum BHP = 1.95 $\left[\frac{\text{RPM}}{1000} \right]^3$									
		Wheel circumference: 6.41'				Fan outlet area = 3.45 sq. ft.															
CFM	OV	2"SP		4"SP		6"SP		8"SP		10"SP		12"SP		13"SP		14"SP		15"SP		16"SP	
		RPM	BHP	RPM	BHP	RPM	BHP	RPM	BHP	RPM	BHP	RPM	BHP	RPM	BHP	RPM	BHP	RPM	BHP	RPM	BHP
6000	1739	1174	2.97	1417	5.23	1644	7.79	1861	10.8												
6500	1884	1232	3.38	1461	5.77	1669	8.38	1877	11.4	2076	14.9	2269	18.8								
7000	2029	1292	3.83	1507	6.35	1707	9.10	1899	12.1	2091	15.5	2276	19.5	2369	21.7	2450	23.7	2537	26.0	2620	28.2
7500	2174	1355	4.35	1557	7.01	1748	9.84	1927	12.9	2107	16.2	2279	20.0	2372	22.2	2455	24.4	2545	26.8	2621	29.0
8000	2319	1416	4.88	1605	7.65	1792	10.6	1969	13.9	2136	17.3	2298	20.9	2378	22.8	2463	25.1	2546	27.4	2625	29.8
8500	2464	1481	5.51	1662	8.42	1838	11.5	2010	14.9	2164	18.3	2325	22.1	2400	24.0	2480	26.1	2558	28.3	2632	30.6
9000	2609	1545	6.18	1720	9.24	1886	12.5	2049	15.9	2204	19.6	2351	23.3	2423	25.1	2499	27.2	2572	29.3	2641	31.5
9500	2754	1608	6.89	1778	10.1	1938	13.5	2097	17.1	2242	20.7	2384	24.6	2459	26.7	2525	28.6	2594	30.7	2668	33.0
10000	2899	1674	7.69	1838	11.0	1991	14.6	2144	18.3	2290	22.2	2422	26.0	2494	28.2	2557	30.2	2624	32.3	2694	34.6
10500	3043	1739	8.55	1902	12.1	2043	15.6	2189	19.5	2331	23.5	2465	27.6	2529	29.6	2596	31.9	2660	34.1		
11000	3188	1806	9.48	1965	13.1	2102	16.9	2238	20.8	2377	24.9	2507	29.1	2575	31.4	2634	33.5	2696	35.8		

SIZE 302		MP		Wheel diameter: 30"				Inlet diameter: 30" I.D.				Maximum BHP = 6.17 $\left[\frac{\text{RPM}}{1000} \right]^3$									
		Wheel circumference: 7.85'				Fan outlet area = 5.17 sq. ft.															
CFM	OV	2"SP		4"SP		6"SP		8"SP		10"SP		12"SP		13"SP		14"SP		15"SP		16"SP	
		RPM	BHP	RPM	BHP	RPM	BHP	RPM	BHP	RPM	BHP	RPM	BHP	RPM	BHP	RPM	BHP	RPM	BHP	RPM	BHP
10000	1934	961	5.11	1138	8.65	1311	12.9	1479	17.7	1639	22.9										
10800	2089	1009	5.83	1177	9.58	1334	13.8	1491	18.6	1645	24.0	1792	29.7	1869	33.0	1936	36.0				
11600	2244	1057	6.61	1217	10.6	1366	14.9	1513	19.8	1657	25.2	1800	31.1	1871	34.3	1940	37.6				
12400	2398	1107	7.50	1260	11.7	1401	16.1	1542	21.2	1680	26.8	1815	32.8	1881	35.9	1946	39.1	2008	42.4	2075	46.0
13200	2553	1158	8.49	1304	12.9	1440	17.5	1570	22.6	1702	28.3	1830	34.3	1892	37.5	1953	40.7	2018	44.2	2080	47.7
14000	2708	1209	9.57	1352	14.2	1481	19.1	1605	24.2	1728	29.9	1850	36.1	1910	39.3	1974	42.8	2029	46.0	2087	49.4
14800	2863	1262	10.8	1399	15.6	1524	20.7	1638	25.8	1758	31.7	1876	38.1	1928	41.0	1988	44.5	2046	48.1	2102	51.5
15600	3017	1316	12.1	1444	17.0	1565	22.3	1678	27.8	1791	33.7	1901	39.9	1956	43.2	2014	46.8	2070	50.4	2117	53.5
16400	3172	1370	13.5	1494	18.7	1612	24.3	1721	29.9	1828	35.9	1935	42.3	1983	45.4	2039	49.1	2087	52.4	2143	56.3
17200	3327	1424	15.0	1543	20.4	1658	26.2	1766	32.2	1863	38.0	1967	44.7	2014	47.8	2064	51.3	2115	55.0		
18000	3482	1480	16.7	1593	22.3	1706	28.3	1809	34.5	1906	40.6	1999	47.0	2050	50.6	2098	54.1	2143	57.5		

SIZE 362		MP		Wheel diameter: 36 1/2"				Inlet diameter: 36" I.D.				Maximum BHP = 15.0 $\left[\frac{\text{RPM}}{1000} \right]^3$									
		Wheel circumference: 9.56'				Fan outlet area = 7.66 sq. ft.															
CFM	OV	2"SP		4"SP		6"SP		8"SP		10"SP		12"SP		13"SP		14"SP		15"SP		16"SP	
		RPM	BHP	RPM	BHP	RPM	BHP	RPM	BHP	RPM	BHP	RPM	BHP	RPM	BHP	RPM	BHP	RPM	BHP	RPM	BHP
15000	1958	814	7.45	960	12.7	1097	18.2	1225	24.4	1346	31.2	1464	38.8	1519	42.6						
16000	2089	847	8.34	987	13.7	1118	19.6	1241	25.8	1360	32.9	1471	40.4	1522	44.1	1577	48.3	1629	52.4		
17000	2219	882	9.30	1017	15.0	1141	21.0	1259	27.4	1373	34.5	1484	42.3	1532	46.0	1584	50.1	1632	54.2	1684	58.7
18000	2350	917	10.3	1046	16.2	1165	22.6	1280	29.2	1390	36.4	1496	44.1	1547	48.2	1597	52.3	1643	56.4	1692	60.9
19000	2480	953	11.5	1079	17.6	1191	24.2	1301	31.0	1407	38.3	1513	46.4	1562	50.4	1609	54.5	1659	59.1	1706	63.6
20000	2611	990	12.7	1111	19.1	1222	26.1	1327	33.2	1427	40.4	1525	48.2	1577	52.6	1622	56.7	1669	61.2	1720	66.2
21000	2742	1027	14.0	1144	20.7	1252	27.9	1352	35.3	1450	42.9	1545	50.8	1591	54.8	1639	59.3	1685	63.8		
22000	2872	1065	15.4	1176	22.4	1281	29.7	1377	37.3	1472	45.3	1565	53.4	1609	57.5	1656	62.0	1700	66.5		
23000	3003	1104	17.0	1211	24.3	1312	31.7	1407	39.7	1498	48.0	1584	56.0	1632	60.6	1672	64.7	1720	69.7		
24000	3133	1143	18.6	1245	26.2	1345	34.0	1436	42.1	1526	50.8	1611	59.3	1653	63.6	1698	68.3				
25000	3264	1181	20.3	1280	28.2	1377	36.3	1468	44.8	1554	53.6	1637	62.6	1679	67.1	1718	71.4				

Performance certified is for installation Type B: Free inlet, Ducted outlet. Power rating (BHP) does not include transmission losses. Performance ratings do not include the effects of appurtenances (accessories).

PERFORMANCE FOR FRP FUME EXHAUSTERS WITH **HP** WHEELS

SIZE 182		HP		Wheel diameter: 18½" Wheel circumference: 4.78'				Inlet diameter: 18" I.D. Fan outlet area = 1.67 sq. ft.				Maximum BHP = .313 $\left[\frac{\text{RPM}}{1000}\right]^3$									
CFM	OV	6"SP		8"SP		10"SP		12"SP		14"SP		16"SP		18"SP		19"SP		20"SP		21"SP	
		RPM	BHP	RPM	BHP	RPM	BHP	RPM	BHP	RPM	BHP	RPM	BHP	RPM	BHP	RPM	BHP	RPM	BHP	RPM	BHP
2600	1557	2253	3.30	2522	4.49	2766	5.73	2994	7.04	3210	8.43	3415	9.87	3626	11.9	3718	12.7	3815	13.5	3917	14.5
2800	1677	2306	3.58	2561	4.78	2797	6.06	3017	7.40	3227	8.82	3429	10.3	3640	12.4	3739	13.3	3828	14.1	3922	15.0
3000	1796	2357	3.86	2606	5.11	2836	6.43	3052	7.82	3258	9.29	3457	10.8								
3200	1916	2418	4.19	2656	5.47	2875	6.80	3086	8.24	3290	9.76	3475	11.3	3657	12.9	3748	13.7	3844	14.6	3931	15.5
3400	2036	2476	4.52	2706	5.83	2921	7.22	3130	8.71	3331	10.3	3517	11.9	3687	13.5	3773	14.3	3863	15.2	3957	16.2
3600	2156	2539	4.88	2761	6.23	2967	7.63	3173	9.19	3363	10.8	3547	12.4	3719	14.1	3811	15.0	3895	15.9	3983	16.9
3800	2275	2605	5.27	2820	6.66	3026	8.15	3216	9.66	3405	11.3	3589	13.0	3761	14.8	3848	15.7	3928	16.6		
4000	2395	2675	5.70	2884	7.15	3083	8.66	3266	10.2	3455	11.9	3630	13.6	3803	15.5	3885	16.4	3961	17.3		
4200	2515	2743	6.13	2947	7.63	3139	9.18	3322	10.8	3495	12.5	3679	14.3	3844	16.2	3923	17.1				
4400	2635	2814	6.60	3014	8.17	3201	9.76	3377	11.4	3552	13.1	3719	15.0	3885	16.9	3960	17.8				
4600	2754	2885	7.08	3080	8.71	3261	10.3	3439	12.1	3607	13.8	3776	15.7	3926	17.5						

SIZE 242		HP		Wheel diameter: 24½" Wheel circumference: 6.41'				Inlet diameter: 24" I.D. Fan outlet area = 3.01 sq. ft.				Maximum BHP = 1.49 $\left[\frac{\text{RPM}}{1000}\right]^3$									
CFM	OV	10"SP		12"SP		14"SP		16"SP		18"SP		20"SP		22"SP		23"SP		24"SP		25"SP	
		RPM	BHP	RPM	BHP	RPM	BHP	RPM	BHP	RPM	BHP	RPM	BHP	RPM	BHP	RPM	BHP	RPM	BHP	RPM	BHP
5000	1661	2081	11.8	2258	14.5	2435	17.5	2594	20.3	2747	23.2	2890	26.1	3031	29.2	3098	30.7				
5500	1827	2102	12.6	2279	15.5	2448	18.6	2601	21.7	2762	25.0	2904	28.2	3045	31.5	3106	33.0	3169	34.5		
6000	1993	2138	13.5	2301	16.5	2464	19.7	2622	23.1	2769	26.5	2908	29.8	3049	33.4	3117	35.2	3174	36.7	3233	38.4
6500	2159	2185	14.6	2338	17.6	2490	20.9	2636	24.3	2779	27.8	2928	31.7	3057	35.2	3119	37.0	3184	38.9	3251	40.9
7000	2326	2237	15.8	2382	18.9	2525	22.2	2661	25.5	2803	29.3	2940	33.2	3068	37.0	3137	39.1	3197	41.0	3258	42.9
7500	2492	2292	17.1	2431	20.2	2567	23.6	2695	27.0	2827	30.7	2954	34.5	3093	39.0	3157	41.1	3212	42.9	3269	44.9
8000	2658	2350	18.4	2485	21.7	2615	25.1	2744	28.8	2869	32.6	2989	36.4	3110	40.5	3179	42.9	3231	44.7	3294	47.1
8500	2824	2407	19.8	2543	23.3	2668	26.8	2791	30.6	2911	34.4	3024	38.2	3147	42.6	3203	44.7	3261	46.9		
9000	2990	2473	21.4	2599	24.9	2726	28.7	2845	32.5	2959	36.4	3068	40.3	3176	44.4	3237	46.7	3291	48.9		
9500	3156	2537	23.0	2665	26.8	2782	30.6	2897	34.4	3007	38.4	3118	42.6	3221	46.7	3280	49.1				
10000	3322	2604	24.7	2724	28.5	2843	32.6	2954	36.6	3068	40.9	3175	45.2	3274	49.3						

SIZE 302		HP		Wheel diameter: 30" Wheel circumference: 7.85'				Inlet diameter: 30" I.D. Fan outlet area = 4.53 sq. ft.				Maximum BHP = 4.53 $\left[\frac{\text{RPM}}{1000}\right]^3$									
CFM	OV	10"SP		12"SP		14"SP		16"SP		18"SP		20"SP		22"SP		23"SP		24"SP		25"SP	
		RPM	BHP	RPM	BHP	RPM	BHP	RPM	BHP	RPM	BHP	RPM	BHP	RPM	BHP	RPM	BHP	RPM	BHP	RPM	BHP
9000	1987	1690	19.3	1832	23.7	1959	28.0	2086	32.8	2211	38.0	2330	43.3	2436	48.4						
9800	2163	1719	20.9	1851	25.3	1975	29.8	2100	34.8	2214	39.7	2331	45.2	2438	50.6						
10600	2340	1751	22.5	1882	27.3	1998	31.8	2115	36.7	2228	41.9	2345	47.7	2454	53.4	2496	55.8	2551	58.9	2608	62.3
11400	2517	1783	24.1	1912	29.2	2028	34.1	2145	39.4	2251	44.5	2360	50.2	2461	55.8	2510	58.6	2560	61.6	2613	64.8
12200	2693	1823	26.0	1941	31.0	2057	36.3	2167	41.6	2274	47.1	2377	52.7	2479	58.7	2525	61.5	2581	65.0	2621	67.5
13000	2870	1861	27.7	1980	33.2	2091	38.7	2196	44.1	2298	49.7	2401	55.7	2498	61.6	2549	64.9	2594	67.8	2640	70.9
13800	3046	1907	29.9	2018	35.3	2125	40.9	2231	46.9	2335	53.0	2434	59.1	2526	65.1	2574	68.3	2616	71.2		
14600	3223	1952	32.1	2059	37.6	2168	43.7	2271	49.8	2364	55.7	2458	61.9	2553	68.5	2599	71.7	2647	75.2		
15400	3400	1999	34.5	2104	40.2	2205	46.1	2304	52.4	2399	58.8	2497	65.6	2580	71.7	2624	75.1				
16200	3576	2046	36.9	2153	43.0	2251	49.1	2347	55.6	2440	62.2	2528	68.7	2622	76.0						
17000	3753	2099	39.8	2195	45.6	2291	51.8	2384	58.4	2474	65.1	2571	72.7	2648	79.1						

SIZE 362		HP		Wheel diameter: 36½" Wheel circumference: 9.56'				Inlet diameter: 36" I.D. Fan outlet area = 6.80 sq. ft.				Maximum BHP = 11.6 $\left[\frac{\text{RPM}}{1000}\right]^3$									
CFM	OV	10"SP		12"SP		14"SP		16"SP		18"SP		20"SP		21"SP		22"SP		23"SP		24"SP	
		RPM	BHP	RPM	BHP	RPM	BHP	RPM	BHP	RPM	BHP	RPM	BHP	RPM	BHP	RPM	BHP	RPM	BHP	RPM	BHP
13000	1912	1384	27.2	1492	33.2	1592	39.3	1693	46.1	1792	53.3	1884	60.7	1939	65.4						
14000	2059	1409	29.2	1511	35.3	1612	41.8	1706	48.5	1797	55.5	1891	63.2	1941	67.7	1977	70.9	2022	75.2	2070	79.9
15000	2206	1432	31.2	1535	37.6	1630	44.2	1719	50.8	1811	58.2	1899	65.8	1946	70.0	1987	73.9	2029	78.1	2074	82.6
16000	2353	1459	33.4	1557	39.9	1648	46.4	1738	53.5	1825	60.9	1915	69.0	1951	72.5	1997	77.0	2037	81.0	2079	85.4
17000	2500	1489	35.8	1583	42.4	1676	49.5	1762	56.7	1845	64.1	1930	72.2	1972	76.3	2008	80.0	2046	84.0	2085	88.2
18000	2647	1521	38.5	1613	45.3	1702	52.5	1785	59.8	1865	67.2	1946	75.3	1986	79.4	2027	83.8	2063	87.8	2100	91.9
19000	2794	1556	41.5	1646	48.6	1733	55.9	1813	63.3	1890	70.8	1968	78.9	2006	83.1	2045	87.5	2079	91.4		
20000	2941	1589	44.4	1678	51.8	1762	59.4	1840	66.8	1920	75.0	1995	83.2	2032	87.4	2070	91.9				
21000	3088	1622	47.2	1708	55.0	1791	62.8	1871	70.9	1949	79.2	2022	87.5	2057	91.7	2094	96.2				
22000	3235	1657	50.2	1742	58.4	1823	66.6	1902	75.0	1977	83.4	2048	91.8	2082	96.0						
23000	3382	1695	53.6	1779	62.2	1854	70.4	1931	79.0	2005	87.7	2079	96.8								

Performance certified is for installation Type B: Free inlet, Ducted outlet. Power rating (BHP) does not include transmission losses. Performance ratings do not include the effects of appurtenances (accessories).

PERFORMANCE FOR FRP FUME EXHAUSTERS WITH **MP** WHEELS

SIZE 422		MP		Wheel diameter: 42" Wheel circumference: 11.0'				Inlet diameter: 42" I.D. Fan outlet area = 10.15 sq. ft.				Maximum BHP = 34.0 $\left[\frac{\text{RPM}}{1000}\right]^3$									
CFM	OV	2"SP		4"SP		6"SP		8"SP		10"SP		12"SP		13"SP		14"SP		15"SP		16"SP	
		RPM	BHP	RPM	BHP	RPM	BHP	RPM	BHP	RPM	BHP	RPM	BHP	RPM	BHP	RPM	BHP	RPM	BHP	RPM	BHP
23000	2266	759	13.8	875	21.7	975	29.7	1071	38.7	1163	48.3	1260	59.3	1308	65.2	1355	71.3				
24200	2384	787	15.3	898	23.4	997	32.0	1086	40.7	1175	50.5	1268	61.6	1314	67.5	1359	73.5	1406	80.2	1447	86.2
25400	2502	814	16.7	923	25.4	1018	34.1	1106	43.3	1193	53.4	1280	64.4	1320	69.7	1362	75.6	1408	82.2	1451	88.8
26600	2621	843	18.4	946	27.3	1041	36.5	1125	45.8	1207	55.8	1291	67.0	1334	73.0	1375	79.0	1414	84.9	1456	91.4
27800	2739	872	20.1	969	29.2	1066	39.2	1146	48.6	1227	59.0	1306	70.0	1343	75.5	1383	81.6	1421	87.5	1465	94.7
29000	2857	901	21.9	995	31.5	1090	41.9	1170	51.7	1247	62.1	1320	72.9	1360	79.1	1399	85.3	1432	90.7	1474	98.0
30200	2975	930	23.9	1020	33.8	1113	44.5	1192	54.9	1266	65.2	1338	76.2	1377	82.6	1411	88.3	1450	95.2		
31400	3094	960	26.0	1047	36.4	1135	47.3	1217	58.4	1290	69.3	1358	80.2	1393	86.0	1430	92.5	1465	98.8		
32600	3212	989	28.3	1076	39.2	1157	50.0	1241	61.9	1310	72.8	1377	84.0	1412	90.1	1448	96.7				
33800	3330	1018	30.7	1103	42.0	1184	53.3	1262	65.0	1333	76.7	1400	88.5	1434	94.7	1466	101				
35000	3448	1048	33.3	1130	45.0	1207	56.4	1285	68.6	1359	81.2	1422	92.9	1455	99.4						

SIZE 482		MP		Wheel diameter: 48" Wheel circumference: 12.6'				Inlet diameter: 48" I.D. Fan outlet area = 13.27 sq. ft.				Maximum BHP = 66.3 $\left[\frac{\text{RPM}}{1000}\right]^3$									
CFM	OV	2"SP		4"SP		6"SP		8"SP		10"SP		11"SP		12"SP		13"SP		14"SP		15"SP	
		RPM	BHP	RPM	BHP	RPM	BHP	RPM	BHP	RPM	BHP	RPM	BHP	RPM	BHP	RPM	BHP	RPM	BHP	RPM	BHP
28000	2110	633	15.7	740	25.6	830	35.5	919	46.9	1008	59.6	1053	66.7								
29500	2223	656	17.3	760	27.7	847	37.9	931	49.3	1016	62.3	1060	69.5	1100	76.4	1144	84.2	1186	92.4		
31000	2336	679	19.1	779	29.8	865	40.6	944	52.0	1025	64.9	1067	72.1	1105	79.0	1147	86.8	1187	94.7	1226	103
32500	2449	702	21.0	799	32.1	882	43.2	960	55.1	1036	67.8	1074	74.6	1114	82.2	1154	90.0	1192	97.9	1229	106
34000	2562	726	23.0	818	34.4	903	46.4	976	58.1	1050	71.1	1086	78.1	1125	85.9	1160	93.1	1198	101	1233	109
35500	2675	750	25.1	838	37.0	923	49.6	993	61.5	1066	75.0	1098	81.5	1137	89.4	1171	96.8	1207	105	1241	113
37000	2788	774	27.2	858	39.5	942	52.8	1012	65.3	1081	78.7	1113	85.4	1147	92.8	1180	100	1215	108	1248	116
38500	2901	799	29.7	879	42.3	961	56.0	1033	69.5	1096	82.5	1131	90.0	1164	97.6	1197	105	1227	113		
40000	3014	823	32.1	901	45.3	980	59.3	1051	73.2	1116	87.3	1147	94.5	1177	102	1209	109	1239	117		
41500	3127	848	34.9	925	48.8	1000	62.9	1071	77.4	1133	91.5	1164	98.9	1193	106	1224	114				
43000	3240	872	37.7	947	52.1	1019	66.6	1090	81.7	1154	97.0	1182	104	1211	112	1242	120				

SIZE 542		MP		Wheel diameter: 54 1/4" Wheel circumference: 14.2'				Inlet diameter: 54" I.D. Fan outlet area = 16.92 sq. ft.				Maximum BHP = 122 $\left[\frac{\text{RPM}}{1000}\right]^3$									
CFM	OV	2"SP		4"SP		6"SP		7"SP		8"SP		9"SP		10"SP		11"SP		12"SP		13"SP	
		RPM	BHP	RPM	BHP	RPM	BHP	RPM	BHP	RPM	BHP	RPM	BHP	RPM	BHP	RPM	BHP	RPM	BHP	RPM	BHP
36000	2128	563	20.3	657	33.0	735	45.6	776	52.9	814	60.3	854	68.2	894	76.8	935	86.1	972	95.2		
38000	2246	584	22.5	674	35.7	752	49.0	789	56.2	827	63.8	862	71.4	900	80.1	936	88.6	975	98.3	1010	108
40000	2364	605	24.9	692	38.6	767	52.3	802	59.4	838	67.1	872	74.9	910	83.9	944	92.5	982	102	1015	111
42000	2482	627	27.5	711	41.7	785	56.3	818	63.4	854	71.4	887	79.5	921	88.1	955	97.0	988	106	1020	115
44000	2600	648	30.1	729	44.9	803	60.3	836	67.8	869	75.7	902	84.0	932	92.1	965	101	997	110	1031	121
46000	2719	671	33.0	747	48.1	822	64.7	855	72.6	885	80.4	915	88.4	945	96.7	977	106	1008	116	1038	125
48000	2837	693	35.9	767	51.9	839	68.7	873	77.4	903	85.6	931	93.4	960	102	992	112	1020	120		
50000	2955	716	39.1	786	55.7	857	73.1	891	82.3	921	90.9	948	99.0	978	108	1006	117	1033	126		
52000	3073	738	42.6	807	59.9	874	77.6	908	87.1	938	96.0	968	105	994	114	1022	123				
54000	3191	761	46.3	828	64.4	893	82.6	927	92.6	957	102	986	112	1012	121	1038	130				
56000	3310	784	50.4	849	69.0	911	87.6	943	97.4	975	108	1004	118	1030	127						

SIZE 602		MP		Wheel diameter: 60" Wheel circumference: 15.7'				Inlet diameter: 60" I.D. Fan outlet area = 20.7 sq. ft.				Maximum BHP = 202 $\left[\frac{\text{RPM}}{1000}\right]^3$									
CFM	OV	2"SP		4"SP		6"SP		7"SP		8"SP		9"SP		10"SP		11"SP		12"SP		13"SP	
		RPM	BHP	RPM	BHP	RPM	BHP	RPM	BHP	RPM	BHP	RPM	BHP	RPM	BHP	RPM	BHP	RPM	BHP	RPM	BHP
40000	1932	479	21.0	567	35.0	646	50.3	685	58.8	724	68.0	763	77.6	802	88.3	840	99.2				
42500	2053	497	23.4	583	38.2	657	53.5	694	62.3	730	71.1	769	81.5	804	91.3	842	103				
45000	2174	516	25.9	600	41.5	671	57.4	706	66.1	740	75.2	775	85.1	811	95.8	845	106	878	117	915	130
47500	2295	536	28.8	617	45.2	686	61.7	718	70.2	751	79.6	783	89.2	815	99.3	850	111	882	122	917	134
50000	2415	556	31.8	634	48.9	702	66.4	732	74.9	765	84.6	796	94.4	827	105	858	116	889	127	919	138
52500	2536	575	35.0	649	52.6	717	71.0	747	79.9	777	89.4	808	99.5	838	110	868	121	895	132	927	144
55000	2657	596	38.5	666	56.6	734	76.1	763	85.5	793	95.5	821	105	849	115	878	127	907	138	935	150
57500	2778	617	42.2	684	61.0	751	81.7	781	91.6	809	102	836	112	863	122	890	133	918	145		
60000	2899	638	46.1	702	65.8	767	86.7	798	97.8	825	108	851	118	877	129	904	140	929	151		
62500	3019	659	50.2	722	71.1	783	92.4	814	104	842	115	867	125	891	136	917	147	941	158		
65000	3140	680	54.7	741	76.4	801	98.7	830	110	857	121	884	133	909	144	932	155				

Performance certified is for installation Type B: Free inlet, Ducted outlet. Power rating (BHP) does not include transmission losses. Performance ratings do not include the effects of appurtenances (accessories).

PERFORMANCE FOR FRP FUME EXHAUSTERS WITH **HP** WHEELS

SIZE 422		HP		Wheel diameter: 42" Wheel circumference: 11.0'				Inlet diameter: 42" I.D. Fan outlet area = 8.99 sq. ft.				Maximum BHP = 23.5 $\left[\frac{\text{RPM}}{1000}\right]^3$									
CFM	OV	10"SP		12"SP		14"SP		16"SP		18"SP		20"SP		21"SP		22"SP		23"SP		24"SP	
		RPM	BHP	RPM	BHP	RPM	BHP	RPM	BHP	RPM	BHP	RPM	BHP	RPM	BHP	RPM	BHP	RPM	BHP	RPM	BHP
18000	2002	1213	37.4	1305	45.4	1396	54.2	1476	62.6	1559	72.2	1644	82.8	1683	87.9	1723	93.5				
19200	2136	1231	39.7	1319	47.8	1405	56.6	1486	65.5	1571	75.6	1651	86.0	1687	90.9	1724	96.2				
20400	2269	1252	42.3	1337	50.5	1424	59.9	1502	68.9	1582	78.9	1658	89.1	1692	93.9	1727	99.0	1764	105	1802	111
21600	2403	1273	44.9	1359	53.6	1438	62.6	1517	72.2	1593	82.2	1665	92.3	1704	97.9	1737	103	1772	108	1808	114
22800	2536	1299	48.2	1379	56.7	1460	66.3	1537	76.0	1610	86.2	1679	96.2	1716	102	1748	107	1781	112	1815	118
24000	2670	1321	51.0	1403	60.2	1477	69.4	1555	79.8	1626	90.0	1692	100	1728	106	1764	112	1796	117	1829	123
25200	2803	1349	54.6	1425	63.7	1502	73.6	1574	83.6	1642	93.8	1711	105	1745	110	1774	115	1811	122		
26400	2937	1376	58.1	1451	67.6	1522	77.2	1591	87.2	1662	98.3	1729	109	1762	115	1796	121	1825	126		
27600	3070	1402	61.6	1476	71.5	1549	82.0	1618	92.3	1682	103	1747	114	1784	121	1812	126				
28800	3204	1431	65.4	1503	75.8	1572	86.1	1639	96.6	1706	108	1769	119	1800	125	1832	131				
30000	3337	1462	69.7	1530	80.1	1598	90.8	1663	102	1729	113	1791	125	1821	131						

SIZE 482		HP		Wheel diameter: 48" Wheel circumference: 12.6'				Inlet diameter: 48" I.D. Fan outlet area = 11.75 sq. ft.				Maximum BHP = 45.6 $\left[\frac{\text{RPM}}{1000}\right]^3$									
CFM	OV	10"SP		12"SP		14"SP		15"SP		16"SP		17"SP		18"SP		19"SP		20"SP		21"SP	
		RPM	BHP	RPM	BHP	RPM	BHP	RPM	BHP	RPM	BHP	RPM	BHP	RPM	BHP	RPM	BHP	RPM	BHP	RPM	BHP
22000	1872	1046	45.9	1132	56.6	1213	67.7	1249	73.1	1288	79.1	1324	84.8	1361	91.2						
23500	2000	1060	48.7	1142	59.4	1219	70.4	1258	76.5	1295	82.4	1328	88.0	1369	95.1	1400	101	1439	108	1473	115
25000	2128	1078	51.9	1157	62.7	1229	73.7	1267	79.8	1302	85.6	1338	92.0	1371	98.0	1406	105	1443	112	1475	118
26500	2255	1094	54.9	1170	65.9	1244	77.7	1280	83.8	1313	89.6	1348	96.0	1379	102	1412	108	1447	115	1483	123
28000	2383	1113	58.5	1187	69.6	1258	81.4	1292	87.6	1324	93.4	1357	99.8	1393	107	1424	113	1457	120	1492	128
29500	2511	1134	62.4	1206	73.8	1275	85.9	1309	92.1	1339	98.0	1372	104	1405	111	1435	118	1467	125		
31000	2638	1155	66.3	1225	78.0	1292	90.2	1324	96.5	1354	102	1390	110	1418	116	1447	122	1477	129		
32500	2766	1177	70.6	1246	82.8	1312	95.3	1343	102	1372	108	1403	114	1434	121	1462	128	1492	135		
34000	2894	1199	74.8	1267	87.6	1331	100	1362	107	1390	113	1424	121	1450	127	1477	133				
35500	3021	1223	79.5	1286	92.2	1350	105	1380	112	1411	119	1440	126	1470	133	1497	140				
37000	3149	1243	83.4	1309	97.4	1371	111	1401	118	1432	125	1460	132	1489	139						

SIZE 542		HP		Wheel diameter: 54 1/4" Wheel circumference: 14.2'				Inlet diameter: 54" I.D. Fan outlet area = 14.95 sq. ft.				Maximum BHP = 84.1 $\left[\frac{\text{RPM}}{1000}\right]^3$									
CFM	OV	10"SP		12"SP		13"SP		14"SP		15"SP		16"SP		17"SP		18"SP		19"SP		20"SP	
		RPM	BHP	RPM	BHP	RPM	BHP	RPM	BHP	RPM	BHP	RPM	BHP	RPM	BHP	RPM	BHP	RPM	BHP	RPM	BHP
26000	1739	916	55.5	990	68.0	1030	75.2	1063	81.6	1103	89.8	1135	96.8	1170	105						
28000	1873	926	58.7	999	71.7	1036	78.9	1072	86.0	1104	93.0	1139	101	1171	108	1205	116				
30000	2007	938	62.2	1012	76.1	1043	82.4	1080	90.3	1111	97.2	1144	105	1179	113	1210	121	1238	128	1273	138
32000	2140	956	66.7	1023	80.2	1057	87.3	1088	94.4	1122	102	1153	110	1181	117	1216	126	1247	134	1274	142
34000	2274	970	70.6	1038	84.8	1070	92.1	1100	99.2	1132	107	1162	115	1193	123	1221	131	1250	139	1281	148
36000	2408	989	75.6	1051	89.4	1086	97.5	1115	105	1146	113	1174	120	1204	129	1231	136	1259	145	1289	154
38000	2542	1007	80.6	1071	95.4	1101	103	1129	110	1159	118	1186	126	1215	134	1245	143	1272	152		
40000	2676	1027	86.1	1090	101	1119	109	1147	116	1175	125	1202	132	1230	141	1259	150	1285	158		
42000	2809	1046	91.4	1107	107	1136	115	1166	124	1191	131	1221	140	1248	149	1272	156				
44000	2943	1067	97.2	1124	113	1156	122	1182	130	1209	138	1238	148	1265	156	1288	164				
46000	3077	1087	103	1147	121	1174	129	1200	137	1227	146	1255	155	1281	164						

SIZE 602		HP		Wheel diameter: 60" Wheel circumference: 15.7'				Inlet diameter: 60" I.D. Fan outlet area = 18.38 sq. ft.				Maximum BHP = 140 $\left[\frac{\text{RPM}}{1000}\right]^3$									
CFM	OV	10"SP		12"SP		13"SP		14"SP		15"SP		16"SP		17"SP		18"SP		19"SP		20"SP	
		RPM	BHP	RPM	BHP	RPM	BHP	RPM	BHP	RPM	BHP	RPM	BHP	RPM	BHP	RPM	BHP	RPM	BHP	RPM	BHP
30000	1632	821	65.0	892	80.5	926	88.6	963	97.9	992	106	1028	116	1056	124						
32500	1768	829	68.7	899	84.7	934	93.6	964	101	995	110	1029	120	1059	130	1086	138				
35000	1904	839	72.8	908	89.7	938	97.5	969	106	1003	116	1030	124	1063	135	1093	145	1119	154	1147	164
37500	2040	851	77.4	917	94.5	949	103	979	112	1010	122	1040	131	1067	140	1095	150	1124	160	1150	170
40000	2176	866	82.5	929	99.8	959	109	987	117	1017	127	1045	136	1075	147	1101	156	1129	167	1154	176
42500	2312	882	88.2	940	105	972	115	999	124	1028	133	1055	143	1083	153	1108	163	1134	173	1162	184
45000	2448	897	93.9	956	112	984	121	1010	130	1038	140	1067	150	1094	161	1118	170	1144	181		
47500	2584	917	101	972	119	999	128	1024	137	1051	147	1079	158	1105	168	1128	178	1153	188		
50000	2720	935	108	990	126	1016	136	1041	145	1067	155	1091	165	1116	175	1142	186	1165	197		
52500	2856	953	115	1006	134	1032	144	1057	153	1082	163	1105	173	1129	184	1155	195				
55000	2992	973	122	1025	142	1051	152	1075	162	1099	173	1122	183	1146	193						

Performance certified is for installation Type B: Free inlet, Ducted outlet. Power rating (BHP) does not include transmission losses. Performance ratings do not include the effects of appurtenances (accessories).

QUICK-SELECTION CURVES

The following charts show comparative performance curves for full-width and 75% narrow-width Medium Pressure [MP], and full-width and 67% narrow-width High Pressure [HP] FRP Fume Exhausters. These curves represent the maximum static pressure and capacity available at each fan's maximum safe operating speed. The charts are intended to assist in initially selecting the proper fan size and design.

Narrow-width fans can generate higher static pressures through higher operating speeds. Maximum safe fan

speeds increase as the wheel width decreases [see maximum safe wheel speed chart for narrow-width wheels on page 11].

For specific operating points of full-width Medium Pressure and High Pressure FRP Fume Exhausters, refer to the performance tables on pages 6 through 9. For points of operation not shown in those tables, or for performance of narrow-width fans, refer to The New York Blower Company Electronic Catalog for further details.

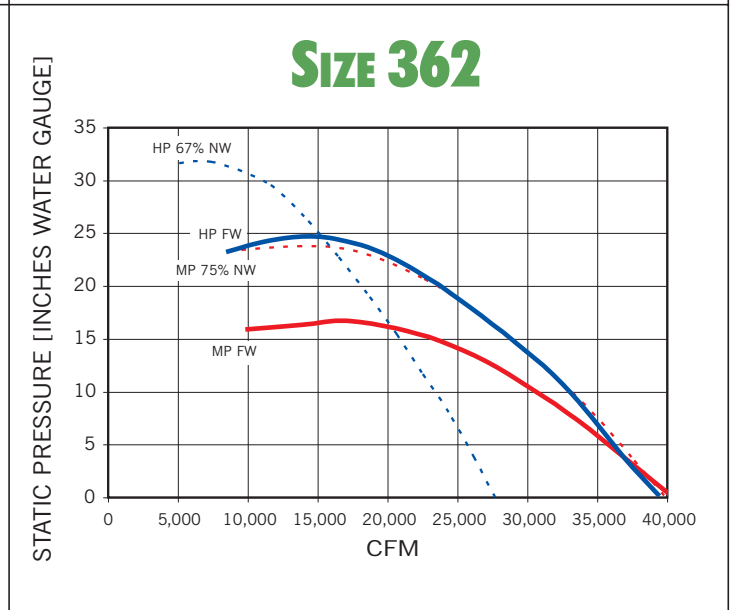
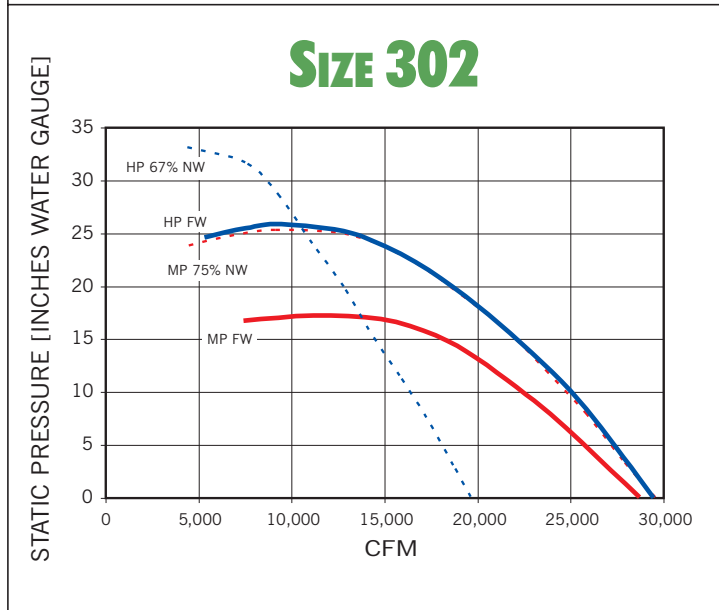
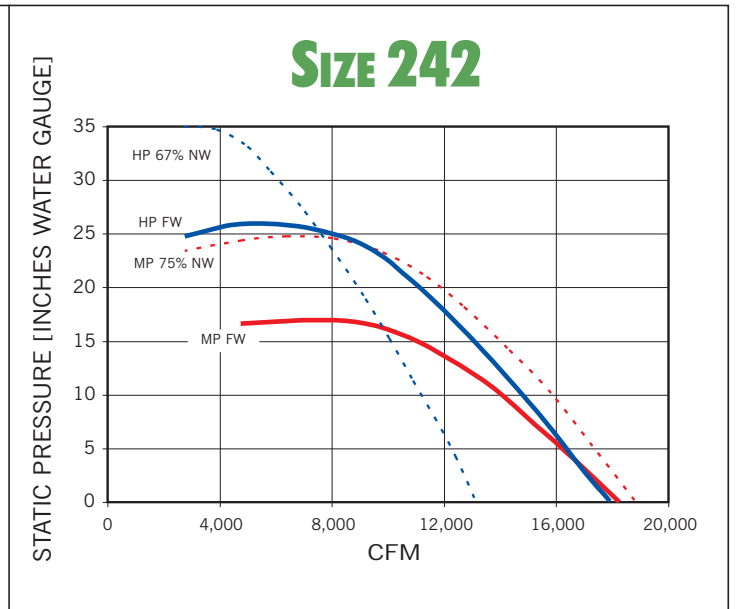
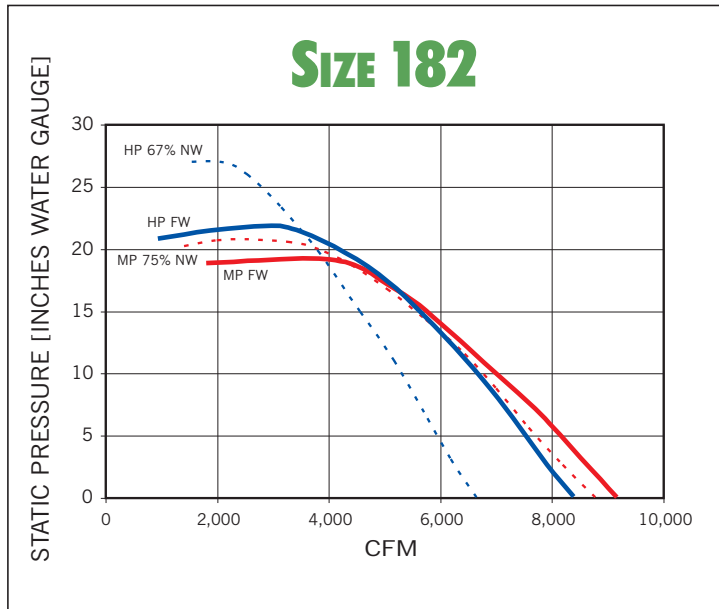

LEGEND

- MP full-width
- HP full-width
- - - MP 75% narrow-width
- - - HP 67% narrow-width

Performance certified is for installation Type B: Free inlet, Ducted outlet. Power rating (BHP) does not include transmission losses. Performance ratings do not include the effects of appurtenances (accessories).

NARROW-WIDTH CONSTRUCTION

Narrow-width wheel construction is available on FRP Fume Exhausters to 75% of full-width on Medium Pressure Fans and to 67% of full-width on High Pressure Fans. Narrow-width construction permits “fine tuning” of fan performance, which is especially critical for Arrangement 8 fans.

Using state-of-the-art design software, narrow-width construction now also enables higher static pressures through higher operating speeds. Chart VI shows the maximum safe speed for narrow-width wheels. The maximum safe speed of wheels increases as the width decreases. Contact your New York Blower representative or refer to your **nyb** Electronic Catalog for additional information.

CHART VI MAXIMUM SAFE WHEEL SPEED FOR NARROW-WIDTH WHEELS AT 70°F

Size	RPM	
	75% NW-MP	67% NW-HP
182	4000	4600
242	3300	3900
302	2650	3145
362	2100	2475
422	1840	2205
482	1500	1780
542	1300	1555
602	1170	1400

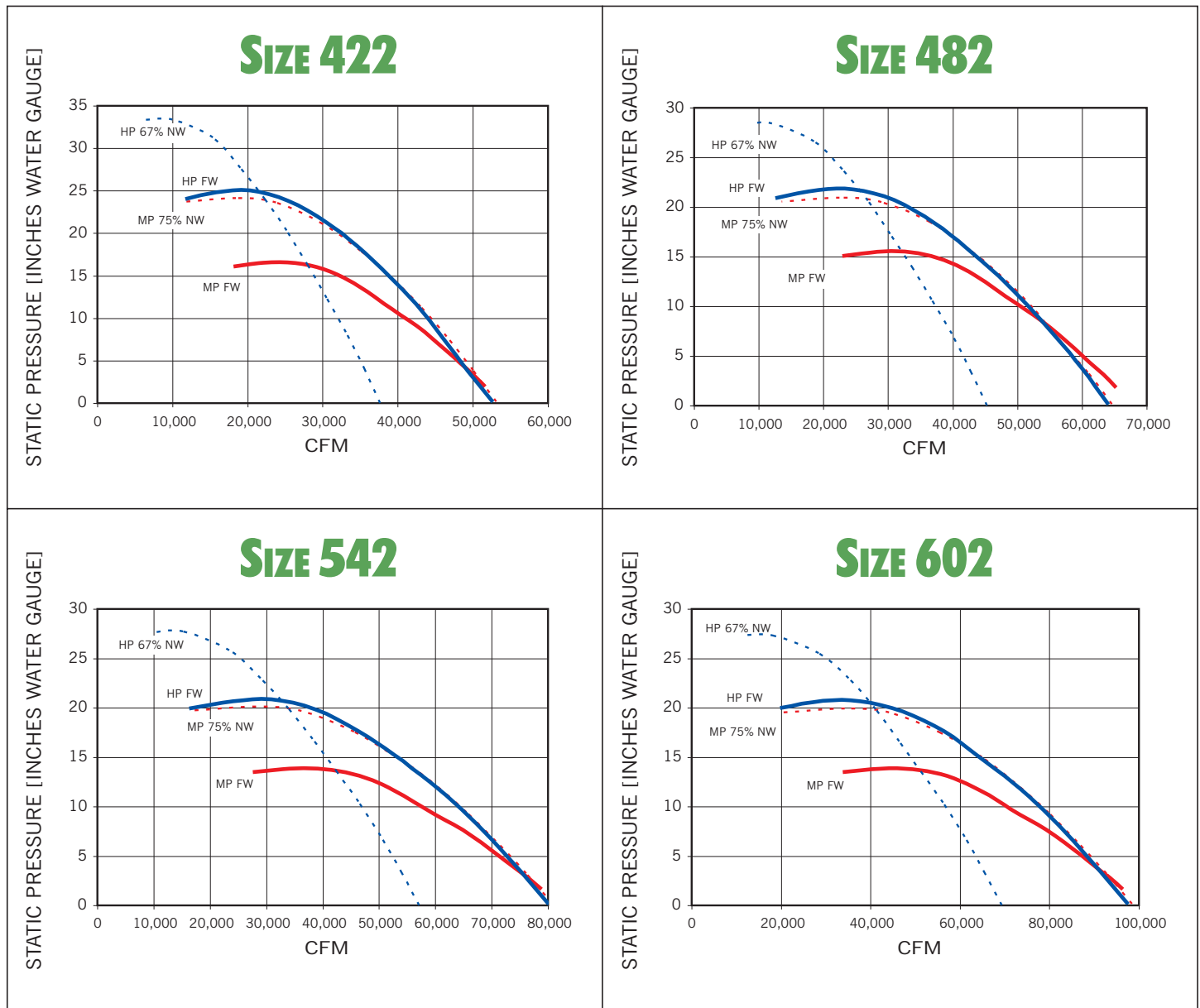

LEGEND

- MP full-width
- HP full-width
- - - MP 75% narrow-width
- - - HP 67% narrow-width

Performance certified is for installation Type B: Free inlet, Ducted outlet. Power rating (BHP) does not include transmission losses. Performance ratings do not include the effects of appurtenances (accessories).

SPECIFICATIONS

Size	Fan type	Shaft diameter [inches]					Bearings										
		Full-width fans			Narrow-width fans		Full-width fans					Narrow-width fans					
		Arr. 1, 8, 9	Arr. 9-E, 9-F	Arr. 10	Arr. 1, 8, 9	Arr. 9-E, 9-F	Arr. 1, 9		Arr. 8	Arr. 9-E, 9-F		Arr. 10	Arr. 1, 8, 9		Arr. 8	Arr. 9-E, 9-F	
							Inboard	Outboard		Inboard/Outboard	Inboard		Outboard	Inboard/Outboard		Inboard	Outboard
182	MP HP	17/16 17/16	17/16 17/16	11 1/16 —	17/16 11 1/16	11 1/16 11 1/16	A B	E E	A B	A B	E E	A —	A D	E D	A D	A D	E D
242	MP HP	17/16 11 1/16	11 1/16 11 1/16	11 5/16 —	11 5/16 11 5/16	11 5/16 2 3/16	A D	E E	A D	A D	E E	A —	E D	E D	D D	D D	E D
302	MP HP	11 1/16 1 5/16	11 1/16 1 5/16	2 3/16 —	2 3/16 2 3/16	2 3/16 2 7/16	A E	E E	A D	A E	E E	C —	D E	E E	D D	D D	E D
362	MP HP	11 5/16 2 3/16	2 3/16 2 7/16	2 3/16 —	2 7/16 2 11/16	2 11/16 2 15/16	D E	E E	D D	D E	E E	C —	D D	E D	D D	D D	E D
422	MP HP	2 7/16 2 1 1/16	2 1 1/16 2 1 1/16	— —	2 1 5/16 3 7/16	3 7/16 3 7/16	E E	E E	D D	E E	E E	— —	F F	F F	D D	E F	E F
482	MP HP	2 1 1/16 2 1 1/16	2 1 1/16 2 1 5/16	— —	3 7/16 3 7/16	3 7/16 3 1 5/16	E E	E E	D D	E E	E E	— —	E E	E E	E F	E F	E F
542	MP HP	2 1 5/16 3 7/16	3 7/16 3 7/16	— —	3 1 5/16 3 1 5/16	3 1 5/16 4 7/16	E E	E E	E F	E E	E E	— —	E E	E E	F F	E F	E F
602	MP HP	2 1 5/16 3 7/16	3 7/16 3 7/16	— —	3 1 5/16 3 1 5/16	3 1 5/16 4 7/16	E E	E E	E F	E E	E E	— —	E E	E E	F F	E F	E F

A—Link-Belt P3-U200 ball bearing. B—Sealmaster SPM ball bearing. C—Sealmaster MPD ball bearing. D—Link-Belt P-U300 ball bearing. E—Link-Belt P-B22400 spherical roller bearing. F—Link-Belt P-LB6800 spherical roller bearing. **nyb** reserves the right to substitute bearings of equal quality.

Size	Weights [lbs.]															Wheel WR ² [lb.-ft. ²]	
	Bare fan										Wheel and shaft assembly						
	Arr. 1, 9		Arr. 8		Arr. 9-E		Arr. 9-F		Arr. 10		Arr. 1, 8, 9		Arr. 9-E, 9-F		Arr. 10		
	MP	HP	MP	HP	MP	HP	MP	HP	MP	MP	HP	MP	HP	MP	MP	HP	
182	235	195	310	270	275	235	NA	NA	285	33	31	36	34	40	7	5	
242	430	395	615	585	530	490	NA	NA	450	56	58	67	64	70	23	21	
302	720	645	985	910	775	695	NA	NA	700	86	90	90	96	103	52	48	
362	1280	1400	OA	OA	1380	1540	1725	1885	1020	142	149	164	174	149	131	118	
422	1695	1870	OA	OA	1825	2000	2255	2430	NA	282	286	311	301	NA	369	345	
482	2150	2315	OA	OA	2225	2445	2695	2910	NA	369	355	380	386	NA	619	576	
542	3070	3285	OA	OA	3255	3450	3950	4140	NA	597	614	662	638	NA	1276	1188	
602	3495	3715	OA	OA	3695	3900	4385	4590	NA	660	675	726	699	NA	1886	1756	

NA—Not available. OA—On application.

FLANGED OUTLET DIMENSIONS [Inches]

Furnished as standard [without holes].

Available with holes drilled as shown.

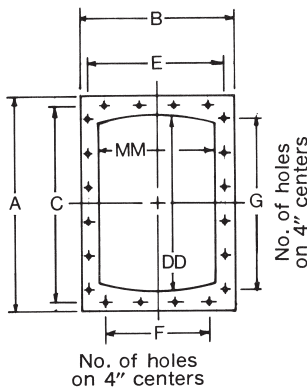

FLANGED INLET DIMENSIONS [Inches]

Furnished as an option [without holes].

Available with holes drilled as shown.

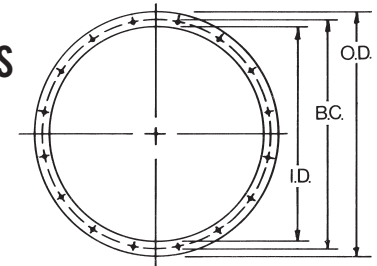

Size	A	B		C	DD	E		F		G	MM		Hole dia.	Flange thickness	Size	O.D.	B.C. [bolt circle]	I.D.	No. and size of holes	Flange thickness
		MP	HP			MP	HP	MP	HP		MP	HP								
182	25 1/8	18	16 1/4	23 3/4	20 3/4	16 5/8	14 7/8	4	2	6	13 5/8	11 7/8	7/16	1/2	182	22 3/8	21	18	16 - 7/16	1/2
242	32 1/8	22 5/8	20 3/8	30 3/4	27 3/4	21 1/4	19	4	4	8	18 1/4	16	7/16	1/2	242	28 3/8	27	24	20 - 7/16	1/2
302	38 3/8	26 3/4	24	37	34	25 3/8	22 5/8	6	4	10	22 3/8	19 5/8	7/16	1/2	302	34 3/8	33	30	28 - 7/16	1/2
362	45 7/8	31 5/8	28 1/2	44 1/2	41 1/2	30 3/4	27 1/8	6	6	12	27 1/4	24 1/8	7/16	5/8	362	40 3/8	39	36	32 - 7/16	1/2
422	54 1/8	37 3/4	34 3/8	51 3/4	47 3/4	35 3/8	31 3/4	8	6	12	31 3/8	27 3/4	9/16	5/8	422	46 3/8	45	42	36 - 7/16	5/8
482	60 7/8	42 1/4	38 1/8	58 1/2	54 1/2	39 7/8	35 3/4	10	8	14	35 7/8	31 3/4	9/16	5/8	482	54 3/8	52	48	44 - 9/16	5/8
542	68	46 7/8	42 1/8	65 5/8	61 5/8	44 1/2	39 3/4	10	8	16	40 1/2	35 3/4	9/16	5/8	542	60 3/8	58	54	44 - 9/16	5/8
602	74 1/2	51 1/4	46 3/8	72 1/8	68 1/8	48 7/8	43 3/4	12	10	18	44 7/8	39 3/4	9/16	5/8	602	66 3/8	64	60	52 - 9/16	5/8

Tolerance: ± 1/64"

ARRANGEMENT 10 FANS

L is OD of collar. DD, FF, and MM are inside dimensions. JJ is from centerline over inlet collar.
Dimensions not to be used for construction unless certified.

DIMENSIONS [INCHES] SIZES 182-362 ROTATABLE HOUSINGS

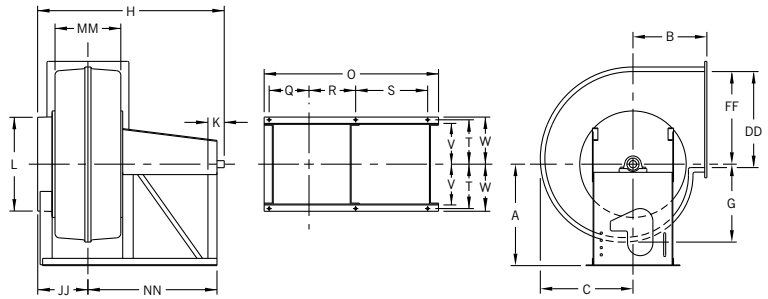

Size	A*	B	C	DD	FF	G	H	JJ	K	L	MM	NN	O
182	21 ¹ / ₄	16	20 ³ / ₈	20 ³ / ₄	19 ¹ / ₂	17 ³ / ₈	41 ¹ / ₈	10 ¹ / ₂	3 ¹ / ₂	18 ¹ / ₂	13 ⁵ / ₈	29	38 ³ / ₄
242	28	20	26 ³ / ₄	27 ³ / ₄	26 ¹ / ₄	22 ⁵ / ₈	50 ³ / ₈	12 ⁷ / ₈	4 ¹ / ₂	24 ¹ / ₂	18 ¹ / ₄	35 ³ / ₈	48 ¹ / ₈
302	32 ¹ / ₂	23 ¹ / ₂	32 ³ / ₈	34	32 ¹ / ₈	27 ³ / ₈	57 ¹ / ₂	16	5 ¹ / ₂	30 ⁵ / ₈	22 ³ / ₈	38 ³ / ₈	53 ¹ / ₄
362	39 ¹ / ₂	29	39 ¹ / ₄	41 ¹ / ₂	39 ¹ / ₈	33 ¹ / ₄	66 ¹ / ₂	19 ¹ / ₂	5 ¹ / ₂	36 ⁵ / ₈	27 ¹ / ₄	43 ⁷ / ₈	61 ¹ / ₄

Size	Q	R	S	T	V	W	a	b	c	d	Square key	Base hole dia.	Max. motor frame size		Max. motor limitation C-NW
													Open	TEFC	
182	8 ⁵ / ₈	9 ³ / ₈	17 ³ / ₈	9 ³ / ₈	8 ¹ / ₄	10 ¹ / ₄	19 ¹ / ₈	26 ³ / ₄	21	15 ³ / ₄	3/8	5/8	215T	215T	16 ⁵ / ₈
242	11 ³ / ₈	12 ¹ / ₂	19 ⁷ / ₈	12 ¹ / ₄	11	13	25	34 ¹ / ₄	27 ⁵ / ₈	20 ³ / ₈	1/2	5/8	256T	254T	18 ⁵ / ₈
302	13 ³ / ₈	14 ⁵ / ₈	20 ³ / ₄	13 ⁵ / ₈	11 ³ / ₄	14 ³ / ₄	30 ¹ / ₄	40 ⁷ / ₈	33 ¹ / ₄	24 ⁵ / ₈	1/2	5/8	284T	256T	19 ¹ / ₂
362	15 ⁷ / ₈	17 ¹ / ₈	23 ³ / ₄	16	14	17	36 ³ / ₄	49 ³ / ₄	40 ⁵ / ₈	29 ⁷ / ₈	1/2	5/8	284T	284T	22 ¹ / ₂

*Add 3" for Bottom Horizontal or Bottom Angular Up discharges. C-NW is maximum motor case length [NEMA C minus NEMA NW]. Tolerance: ± 1/16"

INLET BOXES FOR FRP FUME EXHAUSTERS

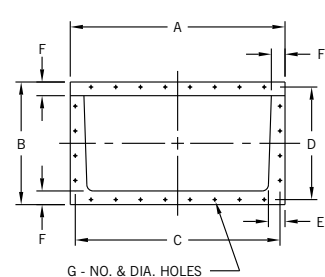
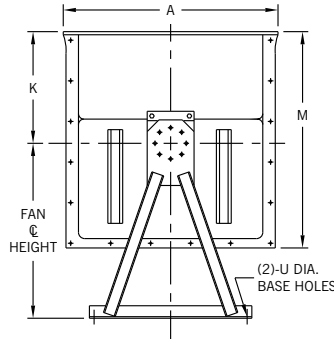
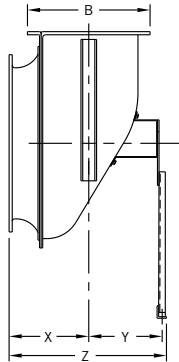
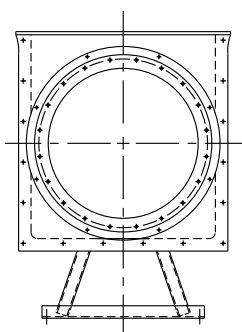

Dimensions not to be used for construction unless certified.

1. Rectangular flange is furnished without holes as standard...available with holes on 4" centers straddling centerlines.
2. Round flange is furnished with holes to match drilling pattern of flanged inlet.
3. Base-bar dimensions match fan base-bar dimensions.

DIMENSIONS [INCHES]

Size	Fan inlet area [ft. ²]	A	B	C	D	E	F	G		K	M	U		X	Y	Z	Wt. [lbs.]
								No.	Dia.			Base hole diameter					
												Arr. 1, 8, 9	Arr. 10				
182	1.76	26 ⁷ / ₈	15 ⁷ / ₈	25 ¹ / ₂	14 ¹ / ₂	29 ¹ / ₁₆	23 ¹ / ₁₆	16	7/16	13 ¹ / ₂	26 ¹ / ₂	9/16	5/8	10 ³ / ₄	9 ³ / ₄	21 ¹ / ₈	75
242	3.14	34 ³ / ₈	19 ⁵ / ₈	33	18 ¹ / ₄	21 ¹ / ₁₆	23 ¹ / ₁₆	24	7/16	17 ⁷ / ₈	34 ⁵ / ₈	3/4	5/8	12 ³ / ₄	11 ¹ / ₄	24 ⁵ / ₈	103
302	4.90	41 ⁷ / ₈	23 ¹ / ₂	40 ¹ / ₂	22 ¹ / ₈	27 ⁷ / ₈	23 ¹ / ₁₆	28	7/16	22 ³ / ₈	42 ⁷ / ₈	3/4	5/8	15 ³ / ₄	13 ³ / ₈	30	138
362	7.07	49 ³ / ₈	27 ¹ / ₄	48	25 ⁷ / ₈	3	23 ¹ / ₁₆	36	7/16	26 ⁷ / ₈	51 ¹ / ₈	7/8	5/8	18 ³ / ₄	14 ³ / ₄	34 ³ / ₈	184
422	9.62	56 ⁷ / ₈	31 ¹ / ₈	55 ¹ / ₂	29 ³ / ₄	3 ¹ / ₈	23 ¹ / ₁₆	44	7/16	31 ³ / ₈	59 ¹ / ₂	7/8	-	21 ³ / ₄	16 ¹ / ₂	39 ¹ / ₈	262
482	12.56	66 ⁵ / ₈	37 ¹ / ₈	64 ¹ / ₄	34 ³ / ₄	4 ¹ / ₄	33 ¹ / ₁₆	48	9/16	35 ⁷ / ₈	67 ³ / ₄	7/8	-	25 ¹ / ₈	21 ⁵ / ₈	48 ¹ / ₈	374
542	15.90	74 ¹ / ₈	40 ⁷ / ₈	71 ³ / ₄	38 ¹ / ₂	4 ³ / ₈	33 ¹ / ₁₆	56	9/16	40 ³ / ₈	76	1	-	28	23 ³ / ₈	52 ³ / ₄	575

Tolerance: ± 1/16"

ARRANGEMENTS 1, 8, 9, 9-E FANS

L is OD of collar. DD, FF, and MM are inside dimensions. JJ is from centerline over inlet collar.
Dimensions not to be used for construction unless certified.

DIMENSIONS [INCHES] SIZES 182-302 ROTATABLE HOUSINGS

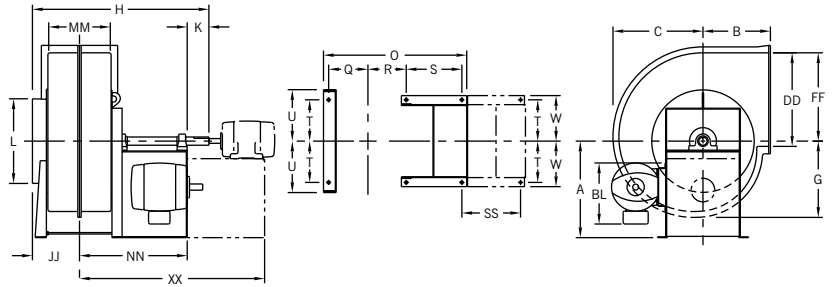

ARRANGEMENTS 1, 8, 9, 9-E FANS

Size	A	B	C		DD	FF	G		JJ		K	L	MM	
			MP	HP			MP	HP	MP	HP			MP	HP
182	21 ³ / ₄	16	20 ³ / ₈	18 ³ / ₄	20 ³ / ₄	19 ¹ / ₂	17 ³ / ₈	15 ³ / ₄	10 ¹ / ₂	9 ⁵ / ₈	4	18 ¹ / ₂	13 ⁵ / ₈	11 ⁷ / ₈
242	28 ⁵ / ₈	20	26 ³ / ₄	25 ¹ / ₄	27 ³ / ₄	26 ¹ / ₄	22 ⁵ / ₈	21 ¹ / ₈	12 ⁷ / ₈	11 ³ / ₄	5	24 ¹ / ₂	18 ¹ / ₄	16
302	34 ³ / ₄	23 ¹ / ₂	32 ³ / ₈	30 ⁷ / ₈	34	32 ¹ / ₈	27 ³ / ₈	26	16	14 ⁵ / ₈	5 ¹ / ₂	30 ⁵ / ₈	22 ³ / ₈	19 ⁵ / ₈

Size	Q		R		T	U	W	a	b	c	d	BL†	Base hole diameter
	MP	HP	MP	HP									
182	8 ⁵ / ₈	7 ³ / ₄	8 ⁷ / ₈	8	9 ³ / ₈	10 ⁷ / ₈	10 ¹ / ₄	19 ¹ / ₈	26 ³ / ₄	21	15 ³ / ₄	17 ¹ / ₄	5 ⁸ / ₁₆
242	11 ¹ / ₂	10 ³ / ₈	11 ³ / ₄	10 ⁵ / ₈	12 ¹ / ₄	14 ³ / ₈	13 ¹ / ₂	25	34 ¹ / ₄	27 ⁵ / ₈	20 ³ / ₈	23 ¹ / ₄	3 ⁴ / ₁₆
302	13 ³ / ₄	12 ³ / ₈	13 ⁷ / ₈	12 ¹ / ₂	14 ⁷ / ₈	16 ⁷ / ₈	16 ¹ / ₈	30 ¹ / ₄	40 ⁷ / ₈	33 ¹ / ₄	24 ⁵ / ₈	28 ³ / ₄	3 ⁴ / ₁₆

† For Arrangement 9 and 9E fans only. BL = slide base (AL + BT) / 2 + motor AB.

Tolerance: ± 1/32"

ARRANGEMENTS 1, 8, 9 FANS

Size	H		NN		O		S	Max. motor limitation*	
	MP	HP	MP	HP	MP	HP		C-NW	Frame
	182	38 ⁵ / ₈	36 ⁷ / ₈	24 ¹ / ₈	23 ¹ / ₄	34 ¹ / ₄	32 ¹ / ₂	13 ³ / ₄	15 ¹ / ₂
242	46 ³ / ₄	44 ¹ / ₂	28 ⁷ / ₈	27 ³ / ₄	42 ¹ / ₂	40 ¹ / ₄	15 ¹ / ₄	18	215T
302	56 ¹ / ₂	53 ³ / ₄	35	33 ⁵ / ₈	50 ³ / ₄	48	19 ¹ / ₄	22	256T

* For Arrangement 9 fans only. C-NW is maximum motor case length [NEMA C minus NEMA NW].
Tolerance: ± 1/32"

ARRANGEMENT 8 FANS

Size	Motor frame	XX		SS
		MP	HP	
182	143T-145T	39	38 ¹ / ₈	15
	182T-184T	40 ¹ / ₂	39 ⁵ / ₈	16 ¹ / ₂
	213T-215T	43 ³ / ₈	42 ¹ / ₂	19 ³ / ₈
	254T-256T	47 ³ / ₄	46 ⁷ / ₈	23 ³ / ₄
242	182T-184T	46 ³ / ₈	45 ¹ / ₄	17 ¹ / ₂
	213T-215T	49 ¹ / ₄	48 ¹ / ₈	20 ³ / ₈
	254T-256T	53 ⁵ / ₈	52 ¹ / ₂	24 ³ / ₄
	284TS-286TS	55 ³ / ₈	54 ¹ / ₄	26 ¹ / ₂
302	324TS-326TS	57 ³ / ₈	56 ¹ / ₄	28 ¹ / ₂
	213T-215T	56 ³ / ₈	55	21 ³ / ₈
	254T-256T	60 ³ / ₄	59 ³ / ₈	25 ³ / ₄
302	284TS-286TS	62 ¹ / ₂	61 ¹ / ₈	27 ¹ / ₂
	324TS-326TS	64 ¹ / ₂	63 ¹ / ₈	29 ¹ / ₂

Tolerance: ± 1/32"

ARRANGEMENT 9-E FANS

Size	H		NN		O		S	Max. motor limitation	
	MP	HP	MP	HP	MP	HP		C-NW	Frame
	182	45 ¹ / ₈	43 ³ / ₈	30 ⁵ / ₈	29 ³ / ₄	40 ³ / ₄	39	20 ¹ / ₄	22
242	55 ³ / ₄	53 ¹ / ₂	37 ⁷ / ₈	36 ³ / ₄	51 ¹ / ₂	49 ¹ / ₄	24 ¹ / ₄	27	326T
302	63 ¹ / ₂	60 ³ / ₄	42	40 ⁵ / ₈	57 ³ / ₄	55	26 ¹ / ₄	29	365T

C-NW is maximum motor case length [NEMA C minus NEMA NW].

Tolerance: ± 1/32"

FAN DISCHARGES – VIEWED FROM DRIVE SIDE

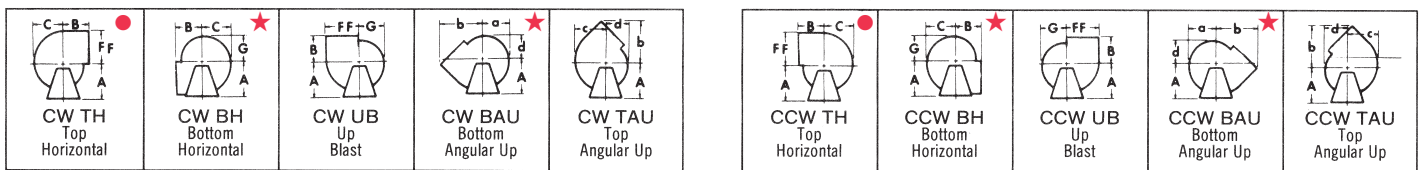

Clockwise—angular discharges at 45°

Counterclockwise—angular discharges at 45°

★ If inlet box is furnished on Sizes 362 to 602 in Top Horizontal fan position, inlet box may extend below floor line.

★ Arrangement 10 fans with Bottom Horizontal or Bottom Angular Up discharges are equipped with a 3-inch channel sub-base...add 3" to the fan centerline height.

The New York Blower Company has a policy of continuous product development and reserves the right to change designs and specifications without notice.

ARRANGEMENTS 1, 9, 9-E, 9-F FANS

L is OD of collar. DD, FF, and MM are inside dimensions. JJ is from centerline over inlet collar.
Dimensions not to be used for construction unless certified.

DIMENSIONS [INCHES]
SIZES 362-602
NON-ROTATABLE
HOUSINGS

ARRANGEMENTS 1, 9 FANS

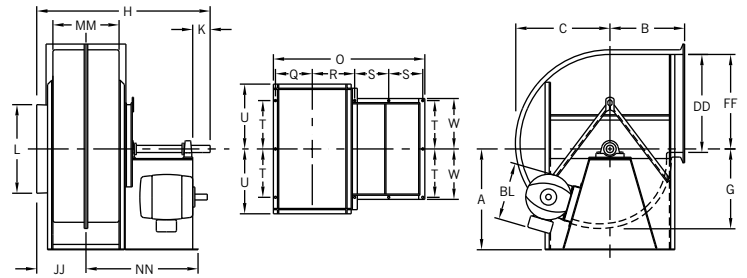

ARRANGEMENTS 9-E, 9-F FANS

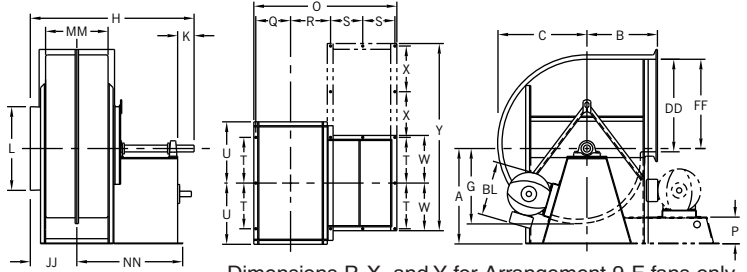

Dimensions P, X, and Y for Arrangement 9-F fans only.

ARRANGEMENTS 1, 9 FANS

Size	H		NN		O		S	Max. motor limitation*	
	MP	HP	MP	HP	MP	HP		C-NW	Frame
362	69 ⁷ / ₈	66 ³ / ₄	46 ¹ / ₄	44 ⁵ / ₈	63 ¹ / ₈	60	13	22	256T
422	80 ¹ / ₄	76 ⁵ / ₈	53 ³ / ₈	51 ¹ / ₂	72 ³ / ₈	68 ³ / ₄	15 ¹ / ₂	27	326T
482	86 ³ / ₄	82 ⁵ / ₈	57 ⁵ / ₈	55 ¹ / ₂	78 ⁷ / ₈	74 ³ / ₄	16 ¹ / ₂	29	365T
542	94	89 ¹ / ₄	63	60 ⁵ / ₈	87 ⁵ / ₈	82 ⁷ / ₈	17	29	365T
602	98 ⁷ / ₈	93 ³ / ₄	65 ¹ / ₈	62 ⁵ / ₈	92	86 ⁷ / ₈	17	29	365T

* For Arrangement 9 fans only.
C-NW is maximum motor case length [NEMA C minus NEMA NW].
Tolerance: ± 1/16"

ARRANGEMENTS 1, 9, 9-E, 9-F FANS

Size	A				B	C		DD	FF	G		JJ		K	L	MM	
	TH	BH, BAU	UB, TAU			MP	HP			MP	HP	MP	HP			MP	HP
362	34	44 ¹ / ₂	40	29	39 ¹ / ₄	37 ⁵ / ₈	41 ¹ / ₂	39 ¹ / ₈	33 ¹ / ₄	31 ⁵ / ₈	19 ¹ / ₂	17 ⁷ / ₈	7	36 ⁵ / ₈	27 ¹ / ₄	24 ¹ / ₈	
422	39	51	46	32 ¹ / ₂	44 ⁷ / ₈	43 ¹ / ₄	47 ³ / ₄	44 ⁷ / ₈	38	36 ³ / ₈	21 ³ / ₄	19 ⁷ / ₈	8	42 ³ / ₄	31 ³ / ₈	27 ³ / ₄	
482	44	57 ¹ / ₂	52	36 ¹ / ₂	51	49 ³ / ₈	54 ¹ / ₂	51 ³ / ₈	43 ¹ / ₈	41 ¹ / ₂	24	21 ⁷ / ₈	8	48 ³ / ₄	35 ⁷ / ₈	31 ³ / ₄	
542	49 ¹ / ₂	65	59	42 ¹ / ₂	57 ⁵ / ₈	55 ⁷ / ₈	61 ⁵ / ₈	58 ¹ / ₈	48 ³ / ₄	46 ⁷ / ₈	26 ⁷ / ₈	24 ¹ / ₂	8	55	40 ¹ / ₂	35 ³ / ₄	
602	54 ¹ / ₂	71 ¹ / ₂	64 ¹ / ₂	46	63 ¹ / ₂	61 ³ / ₄	68 ¹ / ₈	64 ¹ / ₄	53 ⁵ / ₈	51 ⁷ / ₈	29 ¹ / ₂	27	8	61	44 ⁷ / ₈	39 ³ / ₄	

Size	Q		R		T	U	W	a	b	c	d	BL†	Base hole Dia.
	MP	HP	MP	HP									
362	15 ⁵ / ₈	14 ¹ / ₈	18 ³ / ₄	17 ¹ / ₈	17 ¹ / ₂	25	19	36 ³ / ₄	49 ³ / ₄	40 ⁵ / ₈	29 ⁷ / ₈	23 ¹ / ₂	7/8
422	17 ³ / ₄	16	20 ⁷ / ₈	19	20	28 ¹ / ₈	21 ¹ / ₂	41 ⁷ / ₈	57	46 ¹ / ₄	34	30 ¹ / ₄	7/8
482	20	18	23 ¹ / ₈	21	23	31 ³ / ₈	24 ¹ / ₂	47 ¹ / ₂	64 ¹ / ₂	56 ³ / ₄	38 ⁵ / ₈	31 ¹ / ₄	7/8
542	22 ⁷ / ₈	20 ¹ / ₂	27	24 ⁵ / ₈	25	35 ⁷ / ₈	26 ¹ / ₂	53 ⁷ / ₈	73 ³ / ₈	59 ¹ / ₂	43 ⁵ / ₈	35 ¹ / ₄	1
602	25 ¹ / ₈	22 ¹ / ₂	29 ¹ / ₈	26 ⁵ / ₈	26 ¹ / ₂	39	28 ¹ / ₂	59	80 ³ / ₈	62 ³ / ₈	45 ³ / ₄	39 ¹ / ₄	1

† For Arrangement 9 and 9E fans only. BL = slide base (AL + BT) / 2 + motor AB.

Tolerance: ± 1/16"

ARRANGEMENTS 9-E, 9-F FANS

Size	H		NN		O		S	Arrangement 9-F fans only			Maximum motor limitations			
	MP	HP	MP	HP	MP	HP		P	X	Y	Arrangement 9-E		Arrangement 9-F	
											C-NW	Motor frame	C-NW	Motor frame
362	79 ⁷ / ₈	76 ³ / ₄	56 ¹ / ₄	54 ⁵ / ₈	73 ¹ / ₈	70	12	19	76	32	404T	35	405T	
422	89 ¹ / ₄	85 ⁵ / ₈	62 ³ / ₈	60 ¹ / ₂	81 ³ / ₈	77 ³ / ₄	15	19	81	36	405T	39	445T	
482	93 ³ / ₄	89 ⁵ / ₈	64 ⁵ / ₈	62 ¹ / ₂	85 ⁷ / ₈	81 ³ / ₄	15	21	91	36	405T	39	445T	
542	103	98 ¹ / ₄	72	69 ⁵ / ₈	96 ⁵ / ₈	91 ⁷ / ₈	18	25	104	38	405T	42	447TS	
602	107 ⁷ / ₈	102 ³ / ₄	74 ¹ / ₈	71 ⁵ / ₈	101	95 ⁷ / ₈	18	25	107	38	405T	42	447TS	

NOTE: Sizes 362-602 Arrangement 8 pedestal dimensions are dependent on motor size.

Tolerance: ± 1/16"

IN CORROSION-RESISTANT

FRP FANS...

STANDARDS MAKE A DIFFERENCE!

In FRP Fans, construction quality and accurate air ratings are vital. That's where standards make a big difference.

The American Society for Testing and Materials [ASTM] developed a standard specification for FRP fans and blowers. ASTM D 4167, Standard Specification for FIBER-REINFORCED PLASTIC FANS AND BLOWERS, defines minimum specifications for construction of major fan elements. It is a concise, understandable, readily available standard.

The Air Movement and Control Association's [AMCA] Certified Ratings Program provides assurance of accurate ratings. AMCA Standard 210 describes how fans are to be tested for air performance. The AMCA Certified Ratings Program requires the fan manufacturer to guarantee aerodynamic performance within close tolerances of the manufacturer's published ratings.

The Society of the Plastic Industry's [SPI] Users Guide to RP Industrial Equipment, #2-Fans, Guide for Purchasing or Specifying Reinforced Plastic Fans and Blowers, recommends specification of both the ASTM and AMCA standards.

The New York Blower Company's complete line of FRP Fans—Fume Exhausters, Radial Fume Exhausters, Pressure Blowers, General-Purpose Fume Exhausters—meet these standards.



FRP PRESSURE BLOWERS

5,000 CFM
36"WG



FRP RADIAL FUME EXHAUSTERS

7,500 CFM
14"WG



FRP FUME EXHAUSTERS

84,000 CFM
25"WG

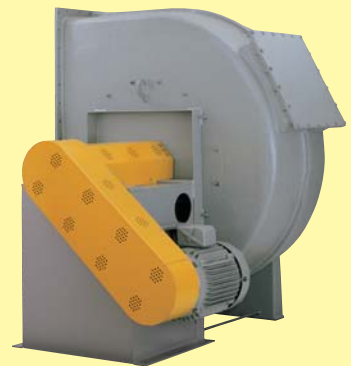

FRP GENERAL-PURPOSE FUME EXHAUSTERS

73,000 CFM
17"WG



THE BEST FRP FANS STILL KEEP COMING FROM NEW YORK BLOWER!